

Draw-Bar Spare Parts

January 2023

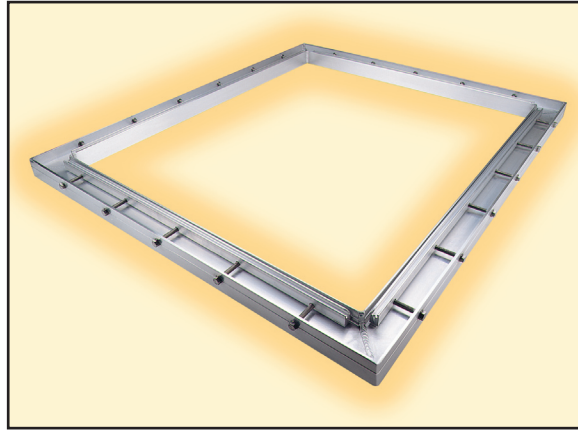

The Diamond Chase Draw-Bar Frame will last you a life time.

The frame is guaranteed watertight for life.

Replacement draw bars, bolts, and the nylon locking rod are available as needed.

Though part replacement is easy to do, Eino Products will do it for you upon request,
call for pricing.

Cylinder Press Frame Rebuild Kits are available - see Draw-Bar Frame price list for pricing.

REPLACEMENT DRAW-BAR PRICE LIST

January 2023



DOUBLE NYLON LOCKING SYSTEM

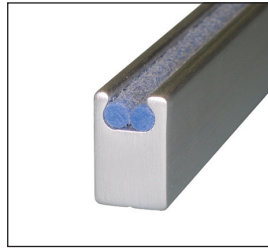
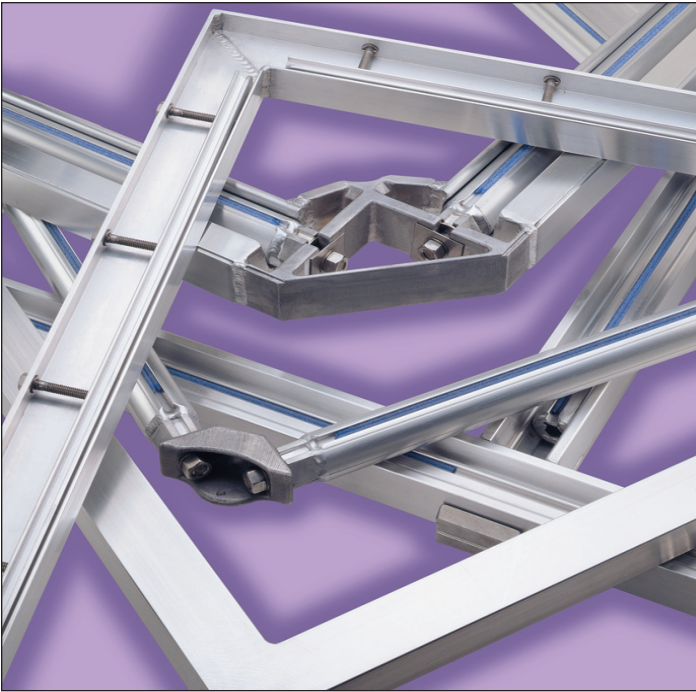

Top Loading Double

Double nylon system where both locking rods snap in together from the top of the draw bar with the assistance of a wheel type insertion tool.

Great all around fabric locking system.

Height .875" (22.2 mm)
Width .562" (14.3 mm)
1/4" or 5/16" Hardware

\$ 1.60 per Inch

KEYSTONE LOCKING SYSTEM

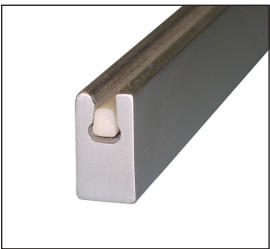

Standard Keystone

Single rod fabric locking system where the rods is slid in from the end of the draw bar. Keystone has increased pre-tensioning ability and works well with stainless meshes.

Height .940" (23.9 mm)
Width .500" (12.7 mm)
1/4" or 5/16" Hardware

\$ 1.40 per Inch

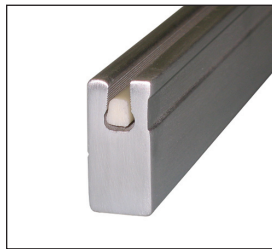

Cylinder Press Keystone

Taller Draw-Bar with the Keystone locking system is designed to fit cylinder press frames. Same benefits as the regular Keystone system with added durability.

Height 1.165" (30.1 mm)
Width .562" (14.3 mm)
5/16" Hardware only

\$ 1.60 per Inch



Dual Keystone

This combination draw bar has both the Keystone locking system and a seperate groove to fit pre-made Shur-Loc* fabric panels. Increased width adds durability and strength.

Height .938" (23.8 mm)
Width .625" (15.9 mm)
1/4" or 5/16" Hardware

Eino / Diamond Chase
(800) 245-5283 ph
(626) 969-1821 ph
(626) 969-1599 fax

418 South Motor Ave.
Azusa, CA 91702

Prices Subject to Change without Notice

REPLACEMENT DRAW-BAR PRICE LIST

January 2023

GLUE-ON SYSTEMS (ALL METAL)



Glue-On Aluminum

Increased fabric tensions by using the stretch & glue method for the primary tensioning. Hardware on the frame is only used for re-tensioning. All metal construction allows for the use of chemical stripping of old adhesive.

Height 1.000" (25.4 mm)
Width .750" (19 mm)
1/4" or 5/16" Hardware



Cylinder Press Glue-On

Taller Draw-Bar allows for gluing contact during the primary Stretch & Glue process when using cylinder press frames. All metal construction allows for the use of chemical stripping of old adhesive.

Height 1.150" (29.2 mm)
Width .750" (19 mm)
5/16" Hardware only

\$ 1.60 per Inch

DETACHABLE INSERT GLUE-ON



D.I. Glue-On

Increased fabric tensions by using the stretch & glue method for the primary tensioning. Hardware on the frame is only used for re-tensioning. Detachable insert bonds excellent and can be replaced for cleaning.

Height 1.000" (25.4 mm)
Width .750" (19 mm)
1/4" or 5/16" Hardware

\$ 1.60 per Inch



Cylinder D.I. Glue-On

Taller Draw-Bar allows for gluing contact during the primary stretch & glue process when using cylinder press frames. Detachable insert bonds excellent and can be replaced for cleaning.

Height 1.250" (31.8 mm)
Width .750" (19 mm)
5/16" Hardware only

\$ 1.70 per Inch

Eino / Diamond Chase
(800) 245-5283 ph
(626) 969-1821 ph
(626) 969-1599 fax

418 South Motor Ave.
Azusa, CA 91702

Prices Subject to Change without Notice

REPLACEMENT PARTS PRICE LIST



January 2023

BOLT SETS (1 Bolt, 2 Washers, 1 Pin)

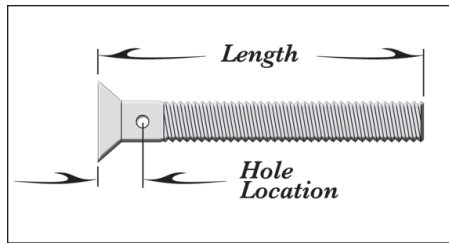
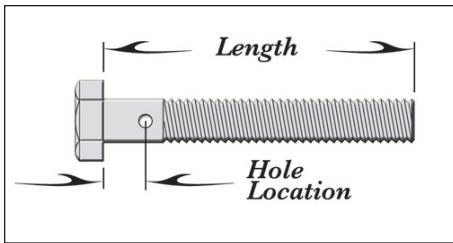

Frame Model	Bolt Length	Hole Dimension	Bolt Set
WC-10 (Hex, Allen, Rec. Allen)	1 ¼"	No Hole	\$ 1.75 each
LJ-20 (Hex, Allen, Rec. Allen)	2"	.300	\$ 2.50 each
WC-20 (Hex, Allen, Rec. Allen)	2"	.420	\$ 2.50 each
WC-20 HD (Allen)	2"	.420	\$ 2.50 each
WC-20 HD (Raised Hex)	2 ½"	.920	\$ 3.00 each
T-175 (Hex, Allen, Rec. Allen)	1 ¾"	.420	\$ 2.50 each
T-175 HD (Hex)	2 ½"	.420	\$ 2.50 each
UC 25 (Hex)	2 ½"	.355	\$ 2.50 each
T-200 (Hex)	2 ½"	.300	\$ 2.50 each
T-200 HD (Hex)	2 ½"	.355	\$ 2.50 each
T-250 (Hex)	2 ½"	.355	\$ 2.50 each
T-300 (Hex Head, Rec. Allen)	3"	.420	\$ 3.50 each
T-400 Triple (Hex Head Only)	4"	.355	\$ 3.50 each
T-500 Triple (Hex Head Only)	5"	.420	\$ 4.50 each
Cylinder Press Frames (Hex Only)	2 ¼"	.355	\$ 2.50 each
BS5-2.5SRA.355 (Rec. Allen)	2 1/2"	.355	\$2.50 each

LOCKING RODS

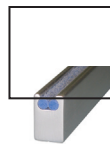

Wedge Style
Keystone Nylon

Round Double
Nylon

Round Double
Top Loading

Glue-On
Inserts

Keystone (Cut to Length)	p/n NYLKST	\$.20 per Inch
Round (White - High Mesh) Cut to Length	p/n NYLONWT	\$.20 per Inch
Round (Blue - Medium Mesh) Cut to Length	p/n NYLONBL	\$.20 per Inch
Round (Black - Low Mesh) Cut to Length	p/n NYLONBK	\$.20 per Inch
Glue On Insert (Cut to Length)	p/n DIINSERT	\$.30 per Inch
Round Rod 15 foot lengths		\$ 27.00 each

MISC HARDWARE

Washers (5/16" or 1/4" & .0625 or .031 Thick)	\$.20 each
Aluminum Spacer for WC-20 Raised Hex	\$.60 each
3/32" Diameter Bend Pins (Tool Kit Required)	\$.45 each
3/32" Diameter Groove Pins	\$.45 each
Draw-Bar Threaded Insert (5/16-18, 1/4-20 or 8mm x 1.25)	\$1.00 each

Prices Subject to Change without Notice

Eino / Diamond Chase
(800) 245-5283 ph
(626) 969-1821 ph
(626) 969-1599 fax

418 South Motor Ave.
Azusa, CA 91702

PIN INSTALLATION KIT

Kit Includes:

Bolt Stabilizer
Pin Shear Tool
Pin Bend Tool

\$ 75.00 Each

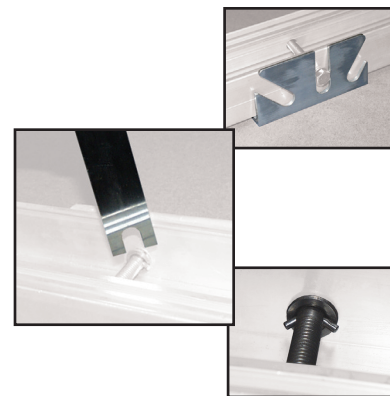

BOLT STABILIZER



The bolt stabilizer aids in holding the head of the bolt when both shearing and bending.

PIN SHEARING

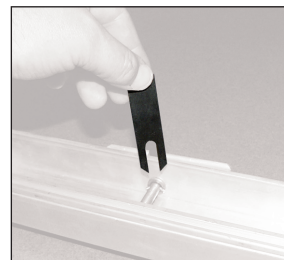

The pin shearing tool cuts the old pin on both side of the bolt with a hit of a hammer.

PIN BENDING

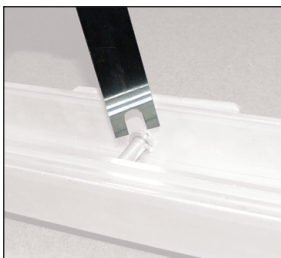

The pin bending tool easily retains the pin around the bolt by forming it in an arc.

INSPECTION



The new bolt / pin replacement

Eino / Diamond Chase
(800) 245-5283 ph
(626) 969-1821 ph
(626) 969-1599 fax

418 South Motor Ave.
Azusa, CA 91702

Always Wear Safety Glasses

Prices Subject to Change without Notice

DRAW-BAR FRAME PRICE LIST

January 2023



PRE-BOW

Two Sides \$ 50.00 per set

Recommend Pre-Bow

1 1/2" to 2 1/2" Profiles	.375" to .500" per side
2 1/2" to 3" Profiles	.500" to .750" per side
3" to 5" Profiles	.750" to 1.500" per side

THREADED INSERTS

Flush Mount, Watertight, Stainless Insert
1/4-20, 5/16-18 or 8mm x 1.25

\$ 21.00 each
\$ 30.00 set-up

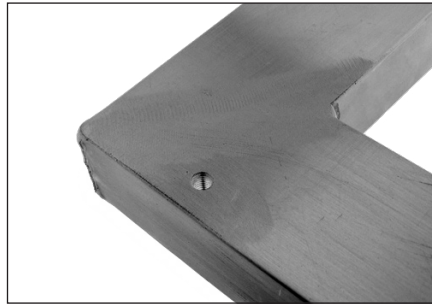

LOCATOR BUSHINGS

Aluminum Plug Drilled \$ 22.50 each
Flush Mount, Watertight \$ 30.00 set-up

Bronze Bushing \$ 25.00 each
Flush Mount, Watertight \$ 30.00 set-up

Stainless Steel Bushing \$ 25.00 each
(Labor Only) \$ 30.00 set-up

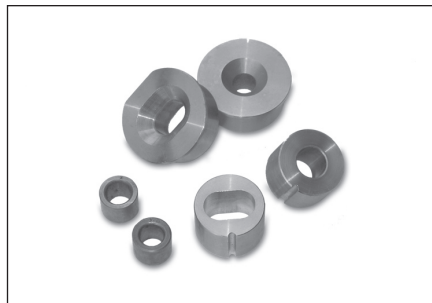

Flush Mount, Watertight
Stainless Steel Bushing Call for Quote

CORNER GUSSETS

Large Format Stretch & Glue Frames
\$ 100.00

Large Format Draw-Bar Frames
\$ 100.00

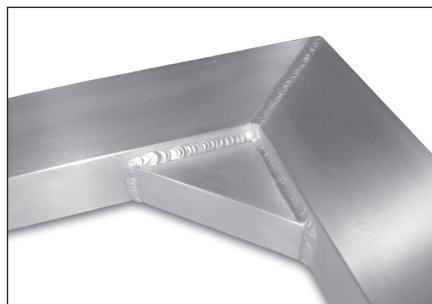

Prices Subject to Change without Notice

Eino / Diamond Chase
(800) 245-5283 ph
(626) 969-1821 ph
(626) 969-1599 fax

418 South Motor Ave.
Azusa, CA 91702

INSERTION TOOL

Wheel Type Insertion Tool
Top Loading Double Nylon Only

\$ 30.00 each



Acrylic Plastic Card
All Double Nylon and Keystone

\$ 3.00 each



INSTRUCTIONAL VIDEOS

Draw-Bar Frame
Tension Quick Fabric Stretcher
Roller Chase

AVAILABLE ONLINE ONLY



MICRO CHASE FRAMES

5" x 5" I.D.	\$ 75.00
5" x 7" I.D.	\$ 92.50
8" x 10" I.D.	\$ 100.00

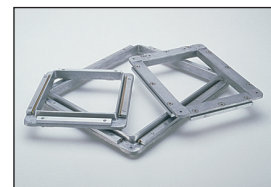

MICRO CHASE REBUILD KITS

CALL FOR QUOTES

Replacement Draw-Bars (with Locking Rods)

5" x 5" I.D.
5" x 7" I.D.
8" x 10" I.D.

Replacement Bolts
Stainless Steel Recessed Allen

Replacement Brass Rods

Eino / Diamond Chase
(800) 245-5283 ph
(626) 969-1821 ph
(626) 969-1599 fax

418 South Motor Ave.
Azusa, CA 91702

Prices Subject to Change without Notice



DIAMOND
CHASE

418 South Motor Avenue
Azusa, CA 91702
(800) 245-5283 ph
(626) 969-1821 ph
(626) 969-1599 fax